

SEW SWEET SACHEL

Finished size approximately 7" x 8"

By: Joan Hawley – Lazy Girl Designs

Supplies:

- 2 - 1" "D" rings (20mm)
- 1 - 1 1/2" "D" ring (30mm)
- 1 - 6" zipper
- 1 zipper pull of your choice
- 1 magnetic snap closure (14mm)
- 2 - swivel clips (10mm)
- Clover 1" bias tape maker
- Mini Iron™ (optional but very useful)

Fabric and Batting:

- 2 coordinating fat quarters for the satchel
- 1/2 yard for the bias binding
- 1 piece of low loft batting at 7" x 13"

Basic sewing and quilting supplies needed.

A walking foot or even feed foot on your sewing machine will be helpful for sewing through all the layers of this project.



General Information:

This wonderful little satchel is a quick and easy project you'll enjoy making. Choose a few different fabrics that work well together and pair them with this wonderful line of purse and bag accessories from Clover Needlecrafts, Inc. for a beautiful project.

Cut all of the pieces listed below and follow the directions and illustrations on the reverse side. The core of the bag is a sandwich made from the Cover, Batting and Lining. Part of this sandwich will fold over and become the front flap for the bag. Layer a back pocket assembly on the Cover and a front pocket on the Lining. All edges should match nicely. Add all of the Clover accessories and finish with a binding and shoulder strap.

Enjoy!

Cut the following fabric pieces:

Cover: cut 1 at 7" x 13"

Lining: cut 1 at 7" x 13"

Front Pocket: cut 1 at 7" x 12"

Back Pocket: cut 1 at 7" x 12"

cut 1 at 7" x 4

Decorative Cover Fob Loop: cut 1 at 2 1/4" x 2 1/4"

Bias Tape: cut strips 1 7/8" wide on the bias. Cut as many strips as needed and sew them together to make a 48" length for the shoulder strap, 40" length for the bag binding and 2 pieces of bias tape at 1 1/2" long for the 'D' rings at the top of the bag.

Over for directions

SEW SWEET SATCHEL

BY: JOAN HAWLEY - LAZY GIRL DESIGNS

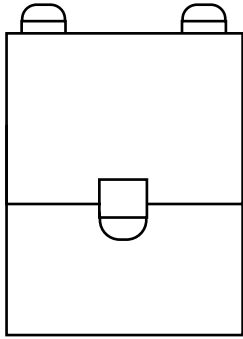

Front

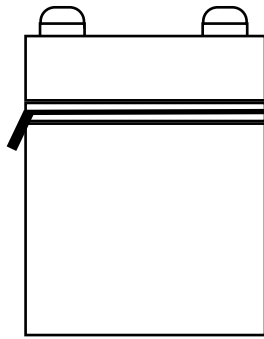

Back

Layer Cover, Batting and Lining, in that order, wrong sides of fabric toward the batting. Match all edges. Pin.

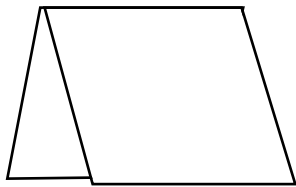
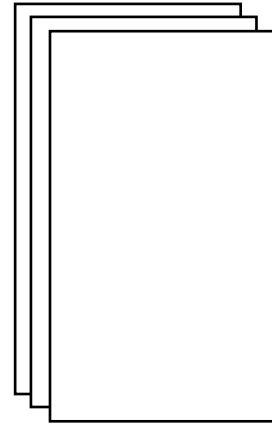

Fold each Back Pocket piece in half, wrong sides together and press. Keep the 7" width of each piece.

Fold →



Place zipper, right side down, match its edge to the raw edge of small Back Pocket piece. Stitch through all layers close to the edge. Fold zipper over stitching toward bottom to expose right side of zipper and press.

Then match the other edge of the zipper to the raw edge of the large Back Pocket piece and stitch. Open and press.

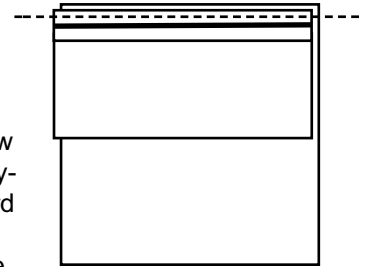

Make bias tape. Cut two pieces 1 1/2" long. Slip each piece through a small 'D' ring, fold in half. Place back pocket on top of Cover, zipper side up, match bottom and side edges. Tuck raw edges of bias loops between pocket and cover. Keep loops 3/4" from side edges. Stitch along top folded edge of pocket through all layers, catching loops in stitching. Fold along stitched line and press to make front flap.

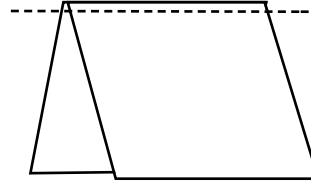
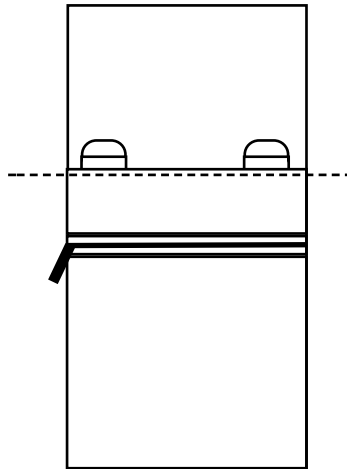

Fold Front Pocket in half, wrong sides together and press. Topstitch along folded edge. Turn satchel over and place Front Pocket on top of Lining, match bottom and side edges. Pin all layers.

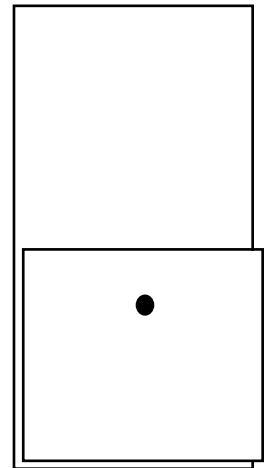

To Finish:

Install magnetic half of snap 1 1/4" from folded top edge of the Front Pocket, centered from side to side as shown in the previous illustration. Install flat half of snap through Lining and Batting. To find the perfect location, fold Lining and Batting over at pressed fold and feel for magnetic half of snap.

Secure all layers of the satchel and stitch around the edge of the satchel, 1/8" from all edges using a walking foot. Make a 40" length of binding bias tape and attach around all four edges of the satchel.

Make a 48" length of bias tape, fold in half to measure approximately 1/2" wide and press. Stitch from end to end to secure all layers. Trim ends, slip ends through swivel clips, fold 1 1/4" back and stitch to secure swivel clips. Attach the zipper pull of your choice to the zipper.

Fold in two side edges of decorative fob fabric to measure 1 1/8" x 2 1/4", wrong sides together. Slip through large 'D' ring and fold in half. Fold 1/4" of raw edges under and press. On the cover, locate the fob fabric just below the flat half of the snap on the lining. Stitch fob fabric in place through all layers. Enjoy!